

Guidelines for Author Supplied Electronic Text and Graphics

Introduction [p. 2](#)

Acceptable File Formats [p. 2](#)

Unacceptable File formats [p. 2](#)

Dots Per Inch [p. 2](#)

Sizing of Graphics [p. 3](#)

Size of Author Photographs [p. 3](#)

Print Color Graphics Requirements [p. 3](#)

Web Color Graphics [p. 3](#)

Fonts [p. 3](#)

Preparing Electronic Graphics
for Submission [p. 3](#)

Naming Convention [p. 3](#)

Multiple-Part Figures [p. 3](#)

Transmitting Graphics Files [p. 3](#)

Graphics Checker Tool [p. 4](#)

Guidelines for electronic text files

The IEEE electronically processes all its Transactions, Journals, and Letters. To complete the production and final printing of your paper, the Transactions Department will need to receive your electronic files in the formats described below.

General Instructions

- 1) Files should be submitted via e-mail, CD, DVD, or on-line manuscript submission as directed by your society/publication.
- 2) Note the operating system, software, and version number used to create your files.
- 3) Make sure your files are self contained, i.e., that there are no pointers to your system setup.
- 4) Check that your file is complete. Please submit one file that contains abstract, index terms, text, references, footnotes, biographies, and figure captions.
- 5) Please include all necessary contact information, including the e-mail address, to which you would like your PDF proof notification sent.

Software

For the most accurate and efficient processing of your manuscript (especially if it contains extensive mathematics), use LaTeX or Microsoft Word. Include macros used with your files. Set manuscript column size to 21 picas (3.5" wide). IEEE LaTeX style files and TRANS-JOUR.DOC, an author template and user's guide for Microsoft Word, are available at: <http://www.ieee.org/organizations/pubs/transactions/stylesheets.htm> When using Word, please use the equation editor for equations or symbols. Manuscripts written in other word processors (such as Wordperfect or Framemaker) are acceptable, but math may need to be rekeyed into a TeX format. Please note that while PDFs should be included with your submission as an accurate representation of your paper, a PDF is not acceptable as an editable source file.

Guidelines for electronic graphics files

Introduction

In order to facilitate the accurate handling of your graphics, the IEEE Transactions/Journals Department has developed the following guidelines. (In this context any line art, graphs,

charts, drawings, tables, and photographs will be referred to as a graphic.)

Acceptable File Formats

All graphics may be submitted electronically in Postscript (PS), Encapsulated Postscript (EPS), Tagged Image File Format (TIFF), Microsoft Word, Microsoft Power Point, Microsoft Excel, or Portable Document Format (PDF). As part of the production process, all submitted files are converted to TIFF format. If there is a problem with your initial submission, your Transactions/Journals staff editor will contact you for a revised electronic graphic. If the revised graphic is unusable, we will scan your hardcopy and you may submit a new graphic during the page proof process. Graphics submitted in other formats may be rejected and may need to be scanned.

Unacceptable File Formats

In general, files prepared as GIF, JPEG, WMF, PNG and BMP (or in any other file formats not listed), are not acceptable and will not be processed. If you have a specific question about formats, please contact the IEEE Graphics Help Desk at graphics@ieee.org.

Dots Per Inch

DPI is an acronym for Dots Per Inch and describes the density of the dots; it is also referred to as "resolution." DPI determines how sharply the image is represented. If a printer specifies 300 DPI, it means that for every inch of image there are 300 dots (or pixels). In order to achieve the highest quality of reproduction, resolutions of 600 dpi (1 bit/sample) at final printed size for line art (graphs, charts, drawing or tables) and 300 dpi (8 bits/sample) at final printed size for photographs and other grayscale images are required by the IEEE.

Using a lower-than-recommended resolution setting may result in degradation of the printed image. Images prepared for Web use with low resolution will not reproduce correctly and will be rejected. Conversely, saving an image at a resolution higher than the recommended settings will not improve the image quality. Image quality is very important to how yours graphics will reproduce. Although we can accept graphics in many formats, we cannot improve the quality of your graphics if the source files are poor.

For highest quality:

- Save line art images (graphs, charts, drawings, or tables) as black and white bitmap and not grayscale.
- Save halftones or photographs and graphics that have combinations of line and tone or shading as grayscale,

and not as black and white bitmap.

Sizing of Graphics

Most charts, graphs and tables are one column wide (3 1/2 inches or 21 picas) or two-column width (7 1/16 inches or 43 picas wide). The maximum depth of a graphic is 9 inches or 54 picas. Please allow space for the caption. The exceptions are for graphics submitted for publication in *The PROCEEDINGS OF THE IEEE* and *IEEE TRANSACTIONS ON PROFESSIONAL COMMUNICATIONS*. We recommend that you avoid sizing figures less than one column wide, as enlargements may distort your images and result in poor reproduction. Therefore, it is better if the image is slightly larger, as a minor reduction in size will not have an adverse affect the quality of the image.

Size of Author Photographs

The final printed size of an author photograph is fixed at exactly 1 inch wide by 1 1/4 inches long (6 picas x 7 1/2 picas). Please ensure that the author photographs you submit are proportioned correctly. JPEG files are accepted for author photos only.

Print Color Graphics Requirements

IEEE accepts color graphics in the following formats: EPS, PS, TIFF, Word, PowerPoint, Excel, and PDF. The resolution of a RGB color TIFF file should be 400 dpi.

When supplying color graphics, please supply a high quality hard copy or PDF proof of each image. If we cannot achieve a satisfactory color match using the electronic version of your files, we will have your hard copy scanned. Any of the files types you provide will be converted to RGB color EPS files.

Web Color Graphics

IEEE accepts color graphics in the following formats: EPS, PS, TIFF, Word, PowerPoint, Excel, and PDF. The resolution of a RGB color TIFF file should be at least 400 dpi.

Your color graphic will be converted to grayscale if no separate grayscale file is provided. If a graphic is to appear in print as black and white, it should be saved and submitted as a black and white file. If a graphic is to appear in print or on IEEE Xplore in color, it should be submitted as RGB color.

Fonts

When preparing your graphics IEEE suggests that you use of one of the following Open Type fonts: Times Roman, Helvetica, Helvetica Narrow, Courier, Symbol, Palatino, Avant

Garde, Bookman, Zapf Chancery, Zapf Dingbats, and New Century Schoolbook. If you are supplying EPS, PS, or PDF files make sure you embed the fonts. Some fonts may only be native to your operating system; without the fonts embedded, parts of the graphic may be distorted or missing.

Preparing Electronic Graphics for Submission

Use lower case letters when naming figures, tables, and author photographs. Figures should contain only the image and not the caption. If your figure has multiple parts, please embed callouts to identify parts of figures, i.e., (a), (b), (c), within the figure. Callouts should be in a Times Roman font with a consistent 8-point size. Avoid mixing point sizes in your graphics.

Naming Convention

Figures (line artwork or photographs) should be named starting with the first 5 letters of the author's last name. The next characters in the filename should be the number that represents the sequential location of this image in your article. For example, in author "Anderson's" paper, the first three figures would be named `ander1.tif`, `ander2.tif`, and `ander3.ps`. Please do not use descriptive names.

Tables should contain only the body of the table (not the caption) and should be named similarly to figures, except that 't' is inserted in-between the author's name and the table number. For example, author Anderson's first three tables would be named `ander.t1.tif`, `ander.t2.ps`, and `ander.t3.eps`.

Author photographs should be named using the first five characters of the author's last name, followed by the type of file TIF, EPS, PS, JPEG, PDF, DOC, PPT, or XLS with the resolution at 300 dpi, 8 bits/sample. For example, four author photographs for a paper may be named: `smith.ps`, `jones.tif`, `lee.eps`, `simps.pdf`, and `moshf.ps`.

Multiple-Part Figures

Please submit your figures so that they are already electronically composed in the way that you would like them published, i.e., stacked or side-by-side. Please include the callouts in the figures.

Transmitting Graphics Files

Files should be submitted via CD, DVD, e-mail or Electronic Manuscript Submission (ask your society representative if this is available to you). Note the operating system, software, and version number used to create your disk (e.g., DOS/Windows

IEEE AUTHOR GUIDELINES

XP/Macintosh/Unix). Write this information on the disk label with a felt pen or include in a readme.txt file with your electronic submission. When using Unix, note method of encoding.

In order to save disk space or to fit a graphic on a disk or in an e-mail, please use compress, pkzip, stffit, or gzip.

Other Hints

- Do not submit images as JPEG, unless they are author photos.
- Do not send images with resolution settings of lower than 300 dpi.
- Be sure to size you images correctly.
- Use the correct image resolution: 600 dpi (1 bit/sample) at final printed size for line art (graphs, charts, drawing or tables) and 300 dpi (8 bits/sample) at final printed size for photographs and other grayscale images.
- The image resolution for print and Web color is 400 dpi at final printed size. A high quality hard copy or PDF proof of each image should be supplied.
- Include all necessary contact information, including email address, phone number, fax number, and mailing address.

Graphics Checker Tool

The IEEE Graphics Checker Tool enables you to check graphic files before they are submitted. The tool will check graphics files against a set of rules for compliance with IEEE requirements. These requirements are designed to ensure sufficient image quality. A report will then be e-mailed, listing each graphic and whether it met or failed to meet the requirements. If the file fails, an explanation will be sent as well as instructions on how to correct the problem.

Link: <http://graphicsqc.ieee.org/>

For questions or more information contact:

Graphics H-E-L-P Desk graphics@ieee.org

A member of the Transactions/Journals graphics staff will respond and may suggest you e-mail a test file.

Examples of BAD Line Art Images

E [V/m]

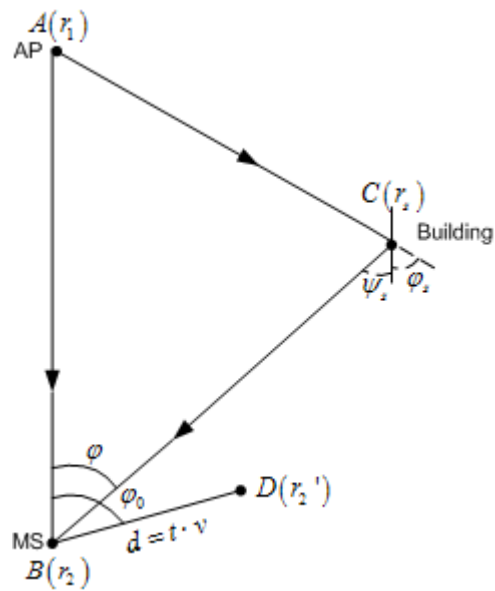
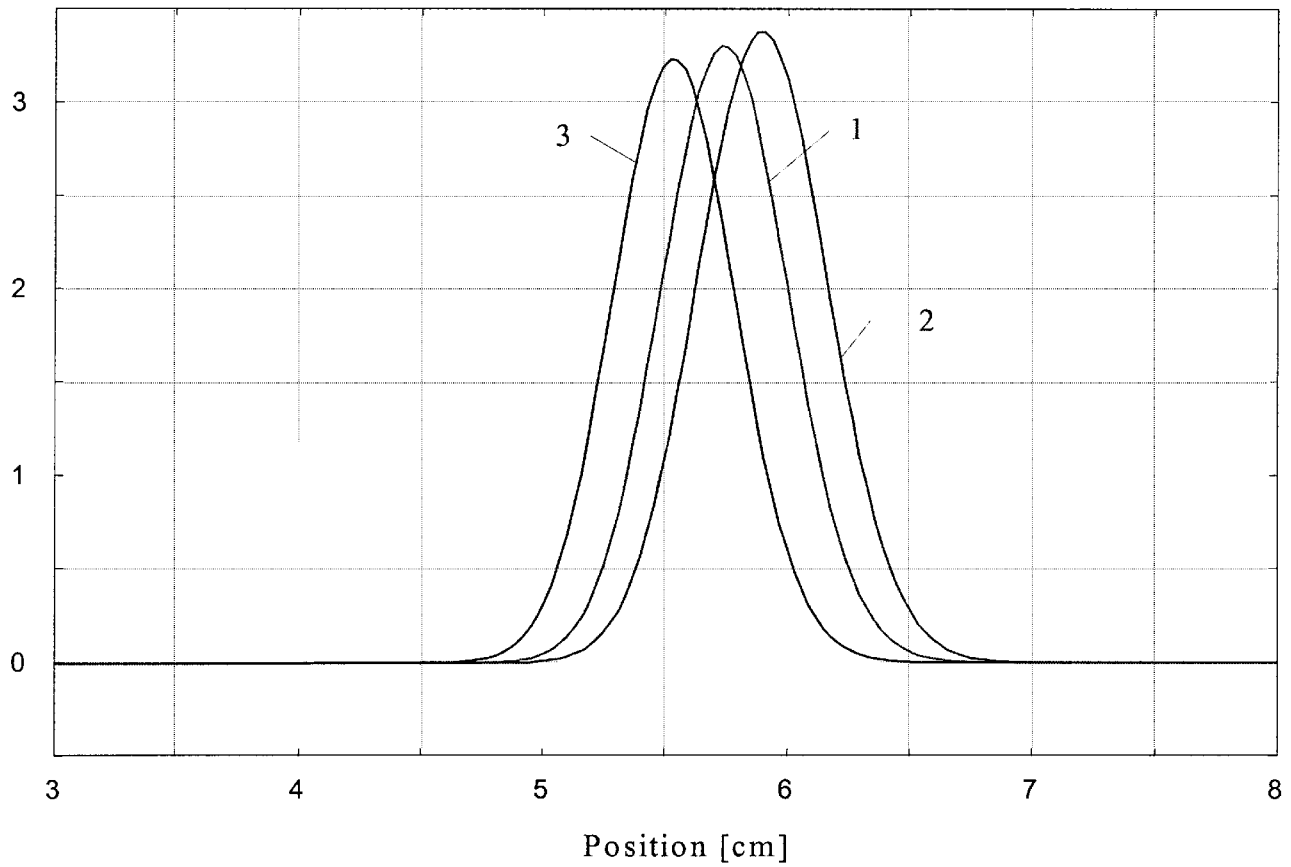

Notice that some of the lines in the figures are dropping away.

Examples of BAD Line Art Images (continued)

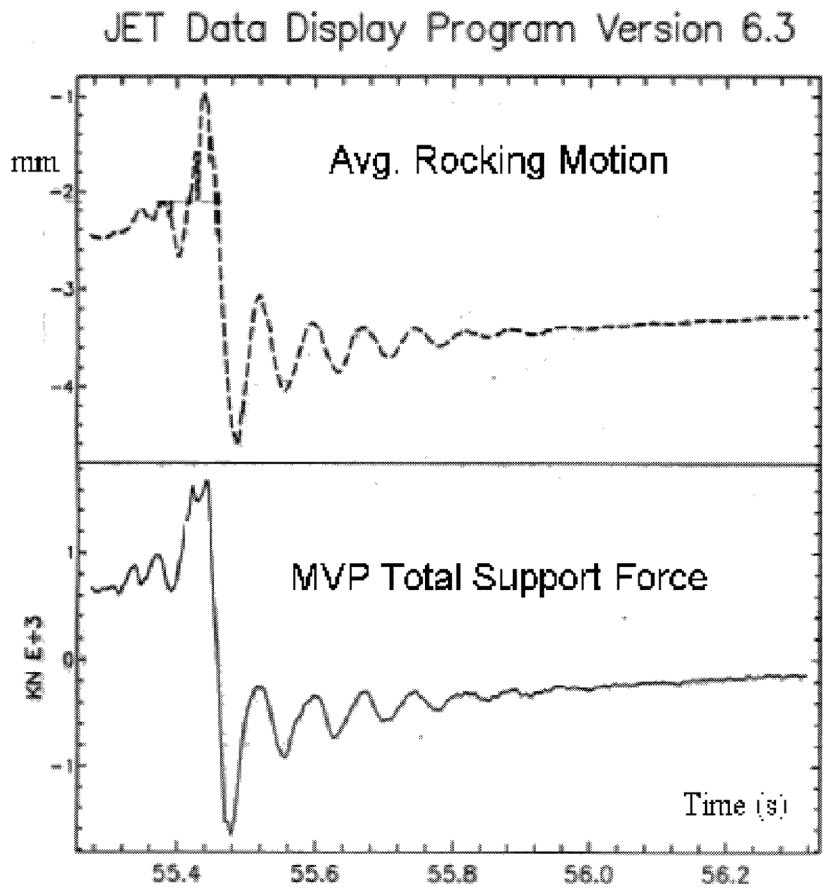

The lines in this graph are fuzzy and the type looks unclear.

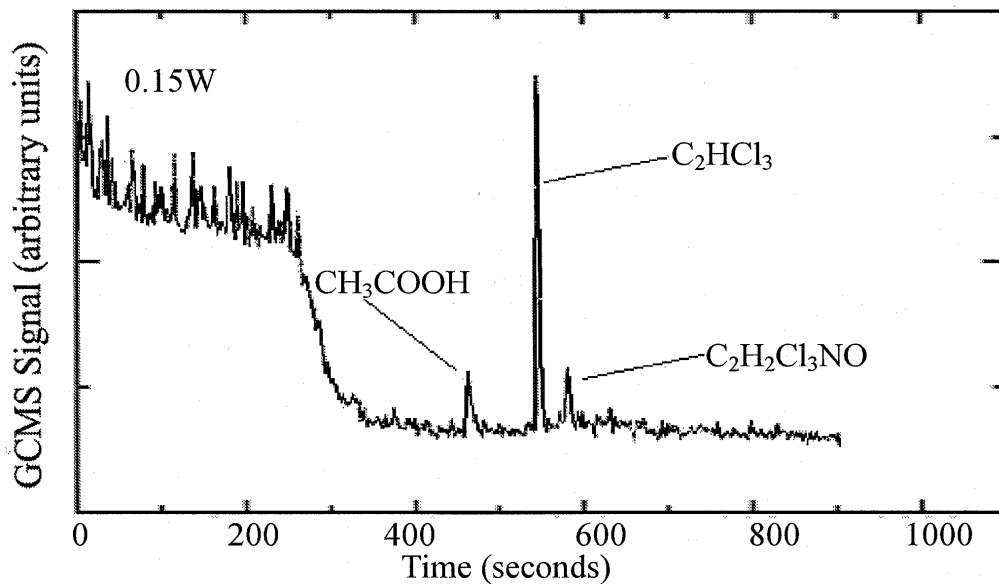

The lines in this graph are fuzzy and seem to blur together making it difficult to decipher.

Examples of GOOD Line Art Images

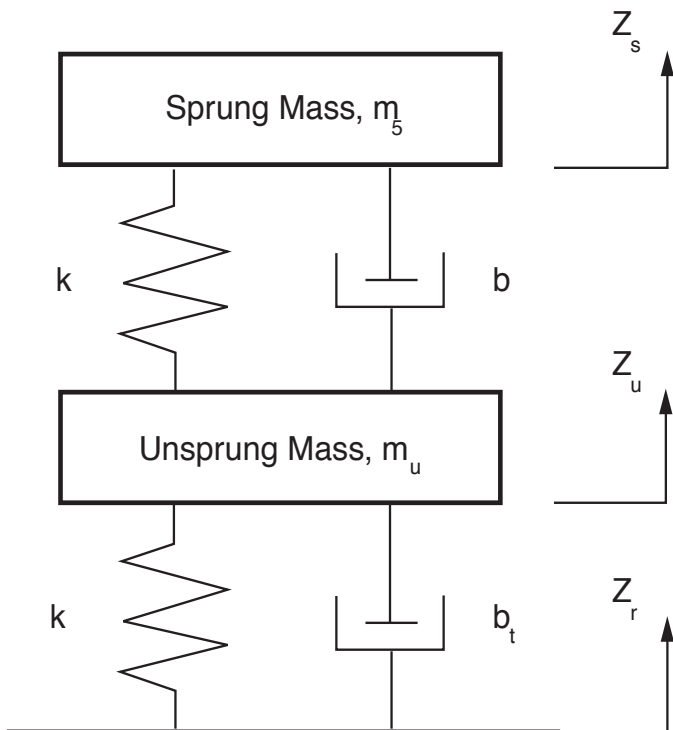
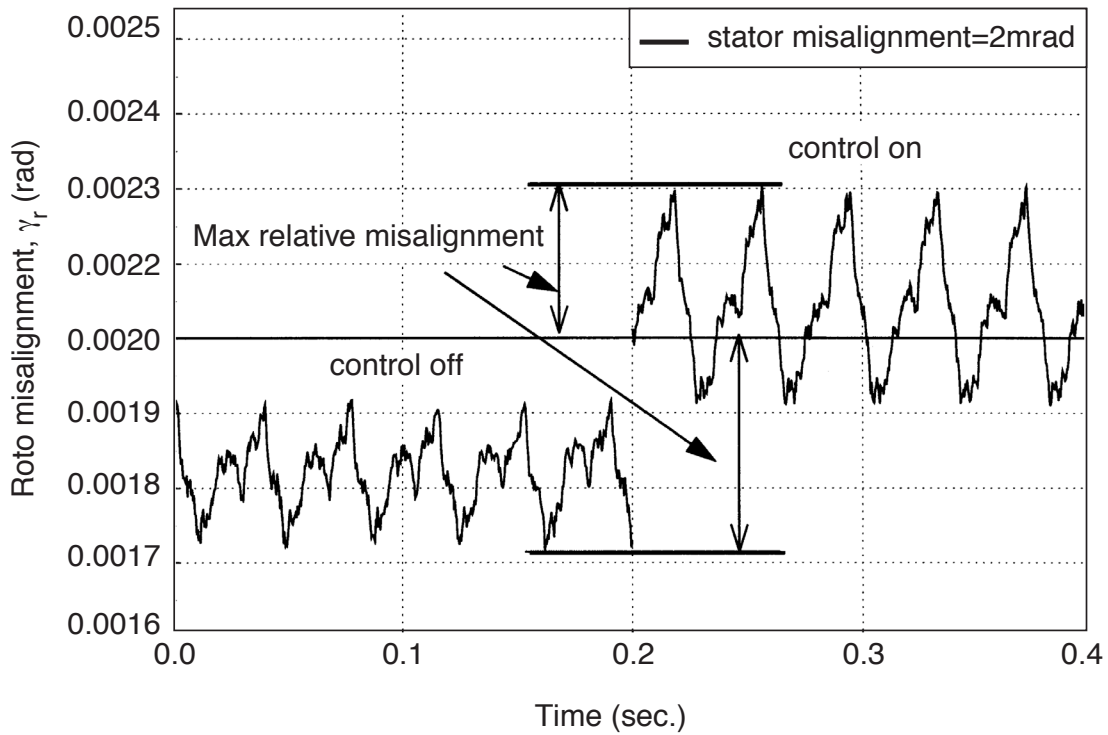

The text in both graphs is easy to read and the lines are clear and sharp.

Examples of GOOD Line Art Images (continued)

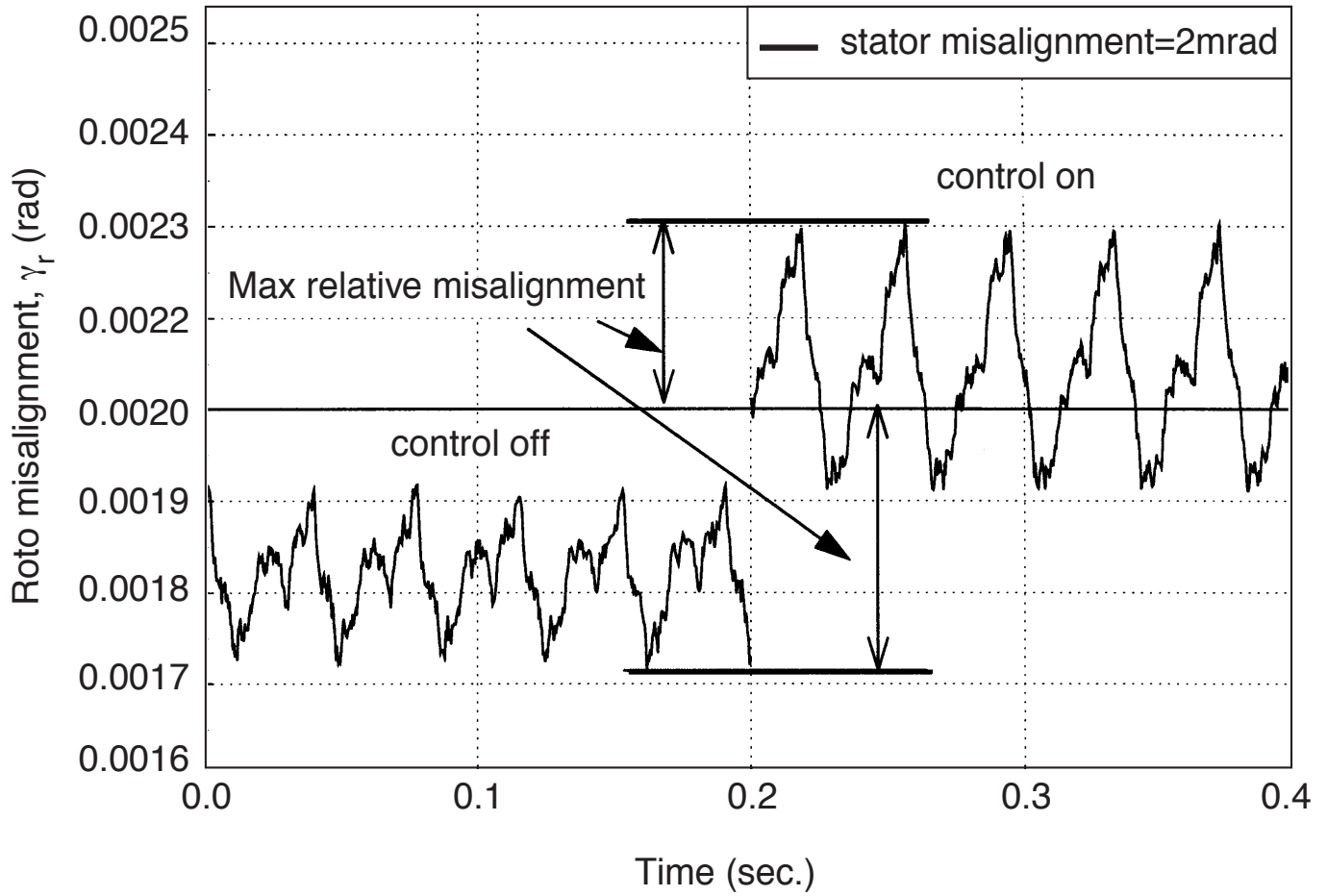

The text is easy to read and the lines are clear and sharp.

**Enlarged Author Photographs Showing Examples
of Both BAD and GOOD Quality**



BAD Quality Image
Photo is blurry and out of focus
Low resolution file (72 dpi)

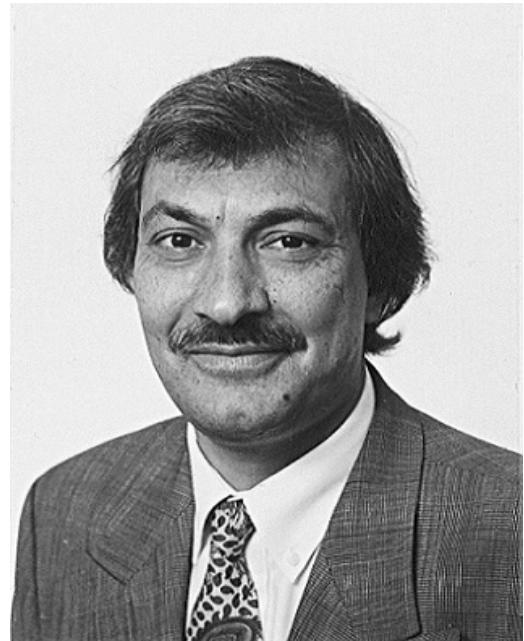

GOOD Quality Image
Photo has detail and is in focus
High resolution file (300 dpi)



BAD Quality Image
Photo is blurry and out of focus
Low resolution file (72 dpi)



GOOD Quality Image
Photo has detail and is in focus
High resolution file (300 dpi)